



**Bobcat**<sup>®</sup>

## Skid-Steer Loaders



***One Tough Animal***<sup>™</sup>

The skid-steer loader can pivot 360 degrees, which makes it one of the **most maneuverable** pieces of equipment available.



## Why Skid-Steer Loaders?

Since inventing the world's first true compact loader in 1958, Bobcat has constantly improved on its original concept: a tough, agile and versatile compact machine that can tackle an incredible number of jobs. | Today, the innovation continues. The Bobcat® skid-steer loader features a superior design that outperforms other brands, while maximizing your uptime and delivering unmatched comfort.



#### **Highly Maneuverable**

The skid-steer loader is compact and pivots 360 degrees, allowing you to easily negotiate close quarters.

#### **Highly Versatile**

From laying sod to demolition, a wide variety of Bobcat-built attachments maximizes equipment usage and expands job possibilities.

#### **Compact Size**

As builders maximize land space, lot lines get tighter. The skid-steer loader's compact size allows you to easily negotiate obstacles and tight spaces.

#### **Extremely Portable**

A lightweight machine can be easily hauled on a trailer. In many cases, you don't even need a commercial driver's license to haul the loader.\*

\* Always check towing restrictions.

#### **Easily see your work**

In a skid-steer loader, the attachment is nearby, visible and unobstructed by a machine hood or tires.

#### **Low Cost**

Compared to larger equipment, skid-steer loaders perform similar tasks in tighter working conditions for a fraction of the cost.

#### **Better Fuel Economy**

Skid-steer loaders offer great fuel economy without sacrificing performance.

#### **Replace Costly Labor**

Labor is expensive and hard to find. With Bobcat skid-steer loaders, you can do more with less and increase your profit.



The best is now even better. With the new M-Series Bobcat® loaders, there's a difference you can see – and a difference you'll experience on the job.

The M-Series Bobcat loader has a completely re-engineered cab that keeps you comfortable, with superior performance that will help you do more, do it faster and do it better.







DELUXE INSTRUMENTATION



SEAT-MOUNTED JOYSTICKS

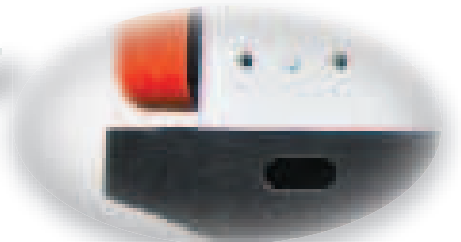

PROTECTED TAILGATE

# The Shape of Things to Come

It's the biggest, most comfortable cab we've ever had, with even better visibility.

**PREMIUM CAB:** Bobcat already has one of the best cabs on the market with the largest cab space in the industry, but when we re-engineered our M-Series loaders, we went even bigger. The new cab, with new positioning and design for better visibility, is the best one yet. Bobcat increased the cab space provided in our traditional loaders by 10% – with more room for your arms, legs, shoulders, head and feet. It's not just bigger; it's quieter. The sound within the cab is reduced by more than 60% for a more comfortable working environment. It also has a best-in-class pressurized interior to keep you clean and comfortable.

**PERFORMANCE:** If you want big performance this is the loader for you. All of the hallmarks of superior Bobcat performance remain, like smart cooling and easy maintenance, but we've further enhanced the machine with stronger hydraulics and 18% improved attachment performance. Increased fuel capacity, powerful lighting and many other features will save you time and effort on the job. Plus, we've protected your machine and simplified maintenance in numerous ways – enabling you to stay on the job longer.

**Cab-Forward Design:** The new cab-forward design moves the operator area closer to the attachment, and gives you a better vantage point for your work area.

**Better Visibility:** Visibility has been significantly increased in all directions. The rear window is 14% larger. The size of the top window is now 43% larger. This provides a big advantage when loading a truck or using attachments with raised lift arms.

The new cab features industry-leading forward visibility down to the bucket, up through the top window and to the back of the machine. The side windows are larger than ever before, increasing your visibility to the tires and the sides.

**Bigger Entry/Exit:** Bobcat re-engineered the largest cab front opening in the industry and made it bigger – and the front cab-door surface area has increased, too. A lowered door threshold gives you an easier entry and exit and increases visibility to your attachment and the surrounding work area – making it easier to see and do your work.



Great performance doesn't only come from a high horsepower engine. Bobcat® loaders use the machine's design and balance to deliver more usable horsepower. We build machines with the right balance between engine and pump, plus a weight distribution that delivers powerful breakout forces and faster cycle times. If you need to work quicker, lift more and outperform the competition, Bobcat compact skid-steer loaders are the only choice.



# Performance



## Stronger Hydraulics

The Bobcat engine, hydraulic pump, horsepower and cubic-inch displacement are configured precisely for each model's specific operating capacity. Engine horsepower and hydraulic system performance are finely tuned to run circles around other machines.

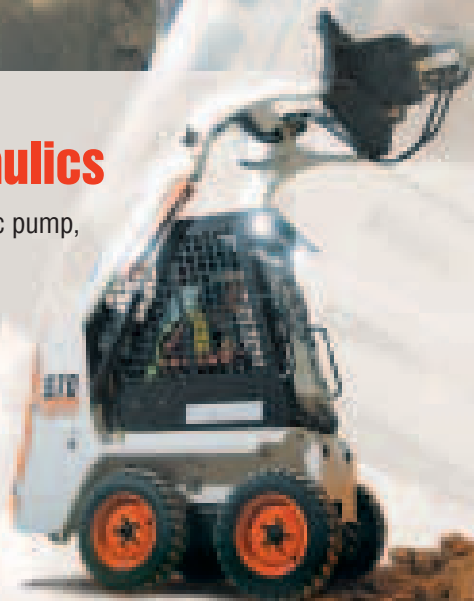

### Quicker Turning

Bobcat's weight distribution of 70% in the rear and 30% in the front delivers ideal performance:

- Best weight distribution for turning and skidding
- Reduces fuel consumption and power requirements from engine
- Increases life of drive train and tires
- Less wear and tear than flat-footed machines from competitors

### Faster Cycle Times

Hydraulic pumps in Bobcat loaders are matched to cylinder size and loader lift capacity to provide fast cycle times that help you get the job done faster.

### More Torque

Bobcat loaders reach maximum torque at a lower RPM to minimize stalling and save time and fuel.

### Control in Your Hands

With Bobcat compact skid-steer loaders, you can feel and control the loader's drive, engine torque and tractive effort – so you can push your machine to the limit without an engine anti-stall system robbing you of power when you need it the most.

### Powerful Breakout Forces

High-efficiency hydraulic pumps deliver more power, matched to demand and providing better breakout forces.

### 2-Speed

Boost top travel speed by as much as 57 percent and reduce the time it takes to travel across a jobsite or between jobs.

### Hydraulic Bucket Positioning

Optional hydraulic bucket positioning keeps your bucket level when raising lift arms, reducing spillage and allowing you to work more efficiently.

[www.bobcat.com/skidsteer](http://www.bobcat.com/skidsteer)



# Uptime Protection

When the skid-steer loader isn't working, nobody's working. That's why Bobcat reliability is legendary. Whether it's our maintenance-free chaincase, smart cooling, superior lift arms, machine shutdown protection, self diagnostics or theft protection, our reputation for reliable equipment protects your reputation for timely, productive work.

## Battery Run-Down Protection

The lighting circuit automatically shuts down to prevent accidental battery discharge.

## No-Maintenance Axle Bearings

Bobcat axle bearings are automatically lubricated with chaincase oil – so they never need greasing.

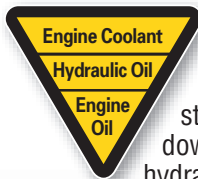

## Machine Shutdown Protection

Bobcat® loaders come standard with automatic shutdown that monitors engine and hydraulic functions. The system alerts the operator and actually shuts the machine down – lessening the chance of damage to the engine or hydraulic components.

## Tougher Axles

Prevent downtime with axles larger than any comparable-sized loader.

## Maintenance-Free Chaincase

The rugged Bobcat® chaincase is the only maintenance-free chaincase in the industry with exclusive fixed axle tubes, stronger axles, fully sealed bearings, plus the largest chains in the industry.

## No Adjustments

The Bobcat chaincase requires no adjustments – ever.

## Largest Chains

Tight manufacturing tolerances. Endless roller, high-strength oval chains. Thick side-link plates and hardened pins. Add it up for chains that are 38% stronger than the competition.

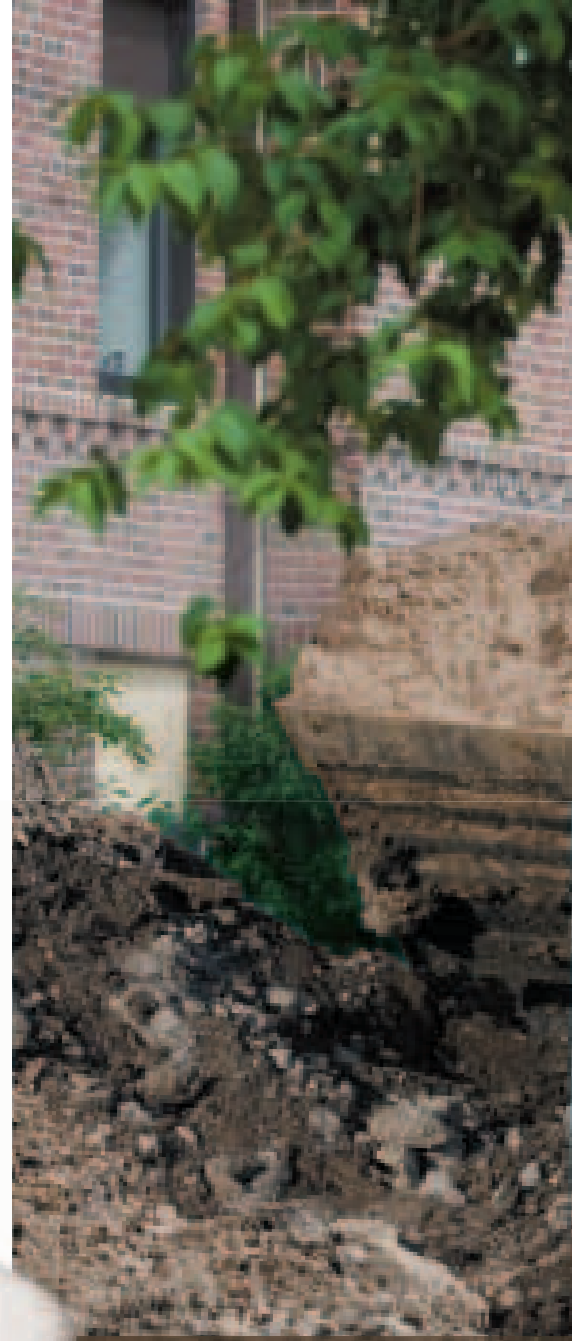





The keel-shaped undercarriage improves performance in soft and wet conditions.

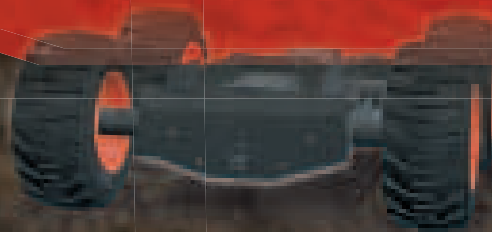

**Go Through More**

The Bobcat keel-shaped undercarriage minimizes your chance of getting stuck. It gives you a higher ground clearance and sheds debris – much like the way a boat slices its way through water.

# Smart Cooling



The Bobcat® cooling system is smarter because of its superior protection, dual-path cooling efficiency and exclusive SmartFAN.

## Quieter Operation

Up to 30% quieter than ordinary cooling fans, Bobcat's hydraulically powered SmartFAN senses the temperature of the machine and only turns as fast as needed. Work in extreme conditions with less concern about overheating.

## More Efficient Cooling

Bobcat loaders have a patented, dual-path cooling system that draws cool, clean air from above; pulls warm air out of the engine compartment and forces it out two side vents, directing hot air away from the operator, cooling

more efficiently and keeping engine components clean. Other systems usually pull dirty air off the top of the tires or below the machine.

## Protected Cooling Location

Some manufacturers still place radiators immediately inside the tailgate. Here they can be damaged by rebar, sticks or other items that can poke through the tailgate ventilation holes. The Bobcat radiator and hydraulic oil cooler are well protected between the frame uprights, above the engine. This also leaves the rear of the engine freely accessible for daily maintenance checks.



Better cooling

in extreme conditions.







# Superior Lift Arms

Your loader arms should remain rigid when you move with a load and hydraulic hoses should be protected from the hazards of a jobsite. Bobcat knows this better than anyone. | Our durable, patented lift-arm design and a choice of lift path help you meet the unique demands of your job.

Higher lift, more capacity and reach at maximum height.

## Vertical Lift Path

A vertical lift path provides higher lift capacity and more reach at full lift height than radius lift path, keeping the load closer to the machine while you raise the loader arms. Because you achieve maximum reach at full lift height, it's easier to clear high-sided truck boxes and hoppers. It's also better for placing heavy pallets of block or sod.



### Job-Matched Lift Arms

A vertical lift path and radius lift path each have their advantages. Bobcat builds both styles to match the work you do.

### Single-Plane Design

Every pin and connecting point on Bobcat® lift arms is part of a single-plane design – so side-to-side movement is minimized, resulting in less wear and longer life. It also helps prevent unwanted spillage of material.

## Radius Lift Path

Radius lift path provides maximum reach at truck bed height. Arm movement forms an arc that delivers a better reach than at flatbed truck height. A radius lift path excels in jobs at mid-range heights, like dumping over a wall, backfilling or unloading flatbed trucks.



More  
reach at  
mid-range.



# Deluxe Instrumentation

The new M-Series Deluxe Instrument Panel offers you even more functionality. The 5-inch, full-color, LCD screen enables monitoring of and interaction with your machine. The system can even provide information about machine performance in English, Spanish and five other languages.

## Password-Protected Keyless Start

Eliminate downtime due to lost keys, reduce the chance of theft and possibly even lower your insurance premiums.

## Attachment Operation

Deluxe Instrumentation features a viewable job clock for certain attachments and the ability to make adjustments to laser-guided attachments without stepping out of the cab. You can even monitor certain attachment functions on screen.

## Diagnostics

The easy-to-read, backlit display panel monitors 14 major loader functions and provides troubleshooting suggestions to help solve a potential problem, which helps maximize your uptime.

## Other Deluxe Instrument Features

Digital time clock, resettable hour meter, attachment controls help menu, both metric and English capabilities plus multiple password settings give you added convenience and more control over your machine.

M-Series Deluxe Instrumentation panel is pictured here. K-Series loaders with Deluxe Instrumentation provide similar functionality, with some exceptions. See your dealer for details.



## BobCare PM<sup>SM</sup> Maintenance Screen

Reminds you when scheduled maintenance is due to ensure you maximize your performance.



**Activity Monitor** Check machine usage by operator with the job clock feature.



**Functional Lockout** Protect your investment from misuse or accidental use by locking out certain functions such as high-flow hydraulics.





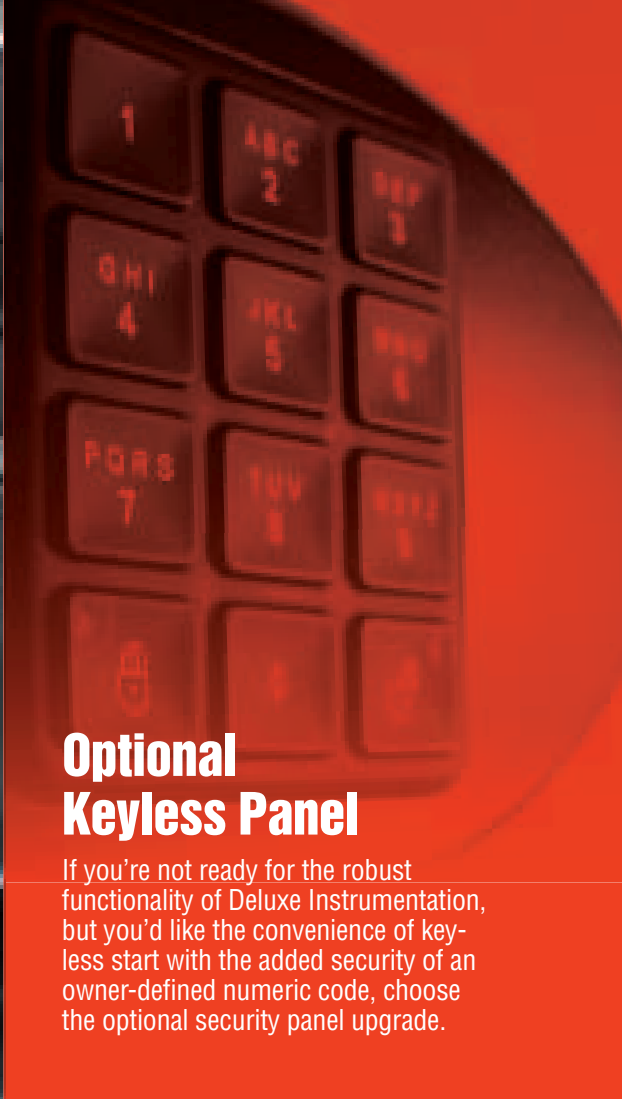

## Optional Keyless Panel

If you're not ready for the robust functionality of Deluxe Instrumentation, but you'd like the convenience of keyless start with the added security of an owner-defined numeric code, choose the optional security panel upgrade.



## Theft Protection

According to the National Insurance Crime Bureau, \$3 million in compact equipment is lost each day to thieves. Compact loaders are one of the most stolen pieces of compact equipment in the world.

Reduce the risk of loss due to theft or unauthorized use with the optional password-protected Bobcat® Deluxe Instrument Panel and up to eight custom keyless start codes. It may even qualify your business for reduced insurance premiums.

[www.bobcat.com/skidsteer](http://www.bobcat.com/skidsteer)



## Comfort Cab

Bobcat pays as much attention to operator comfort as we do to performance. Many comfort options found in Bobcat® loaders aren't even available on other machines.

It's the biggest, most  
comfortable cab  
we've ever had.

### **Seat-Mounted Joysticks**

On M-Series Loaders with Selectable Joystick Controls (SJC), the joysticks are mounted to the seat. As your suspension seat moves up and down, the joysticks move with the seat for added comfort while operating.

### **Improved Seat Adjustment**

The adjustable seat features two additional inches of forward or aft movement to accommodate different-sized operators.

### Large Entry

On machines with enclosed cabs, large swing-open doors provide ample room for exit and entry.

### More Room

Our stronger, narrower loader arms make a wider cab possible, with up to 20% more interior space than competitors, keeping you comfortable.



### Heat and Air Conditioning

Because our AC units are integrated into the machine, there is no bulky add-on unit to obstruct your visibility. Automotive-style vents allow you to point your air where you need it for greater comfort in all weather conditions.

### Convenient Storage

Storage bins are located throughout the interior. You can store items wherever it's convenient – on your right or on your left.

### Convenient Engine Speed Control

The engine speed control has been moved out in front of the operator, on the right-hand corner post of the cab.



### Air-Ride Seats

Achieve optimum suspension comfort with the optional air-ride seat. Air suspension adjusts to your weight, helping you smooth out the bumps on your jobsite and increasing your comfort.

### Fingertip Controls

Fingertip controls make your attachment more comfortable to operate, easier to control and simpler to adjust while driving. Dual-direction detent allows hydraulic flow to be engaged continuously, in either direction, without holding a switch. Variable hydraulic flow allows you to slowly move cylinders when working with a grapple or combination bucket, or crank it up to maximum flow to quickly shake dirt from an auger bit.



### Ride Control

Bobcat Ride Control cushions the loader lift circuit to better absorb shocks caused when carrying loads over uneven ground.

### 12-Volt Power Accessory

Your cab is your office. That's why Bobcat installed a 12-volt power accessory for charging your mobile phone, MP3 player or other accessories.

### Radio Capable

Order your loader with a stereo to increase your comfort. The radio features an auxiliary audio input jack that is ready for an MP3 player or other device.



### Easy-Pull, Easy-Secure Side Window

Simply pull the new window knob to slide the side window to five lockable positions. The window stays exactly where you want it to get consistent air flow.

### Other Comfort Cab Features

- Sound reduction option for even lower noise levels
- High output halogen lights for low-light operation
- Top window for raised-load visibility
- Adjustable pedals

Availability of some comfort features vary by model. See your dealer for details.





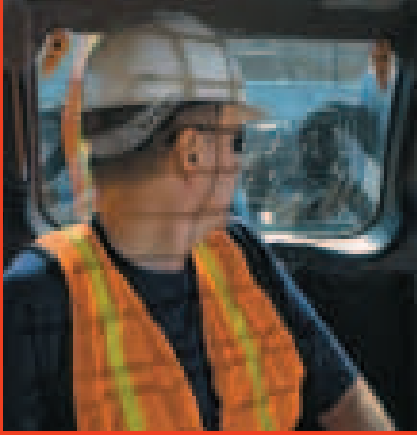



## Improved Visibility

Visibility is increased in all directions on new M-Series loaders. The rear window is 14% larger and the top window is 43% larger. This provides a big advantage when loading a truck or using certain attachments.

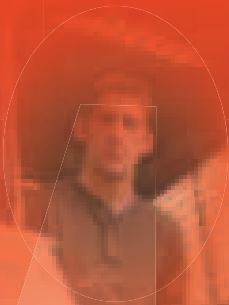
All-around visibility is central to the design of the cab on Bobcat loaders. Good sightlines to the tires increase your performance when operating in tight areas, such as grading next to a building or backing onto a trailer.



The innovative Bobcat design includes a one piece seal. Plus, the unique, curved door pocket provides the best possible seal against dust, dirt and debris.



Even on harsh, dirty jobsites,  
you can stay cleaner and  
more comfortable.

## Pressurized Cab

In your line of work, you have to dive right in – where the dirt, dust, mud and debris are at their worst. Bobcat® M-Series loaders with enclosed cabs have a best-in-class pressurized interior space that keeps dust to a minimum, keeping operators clean and comfortable.



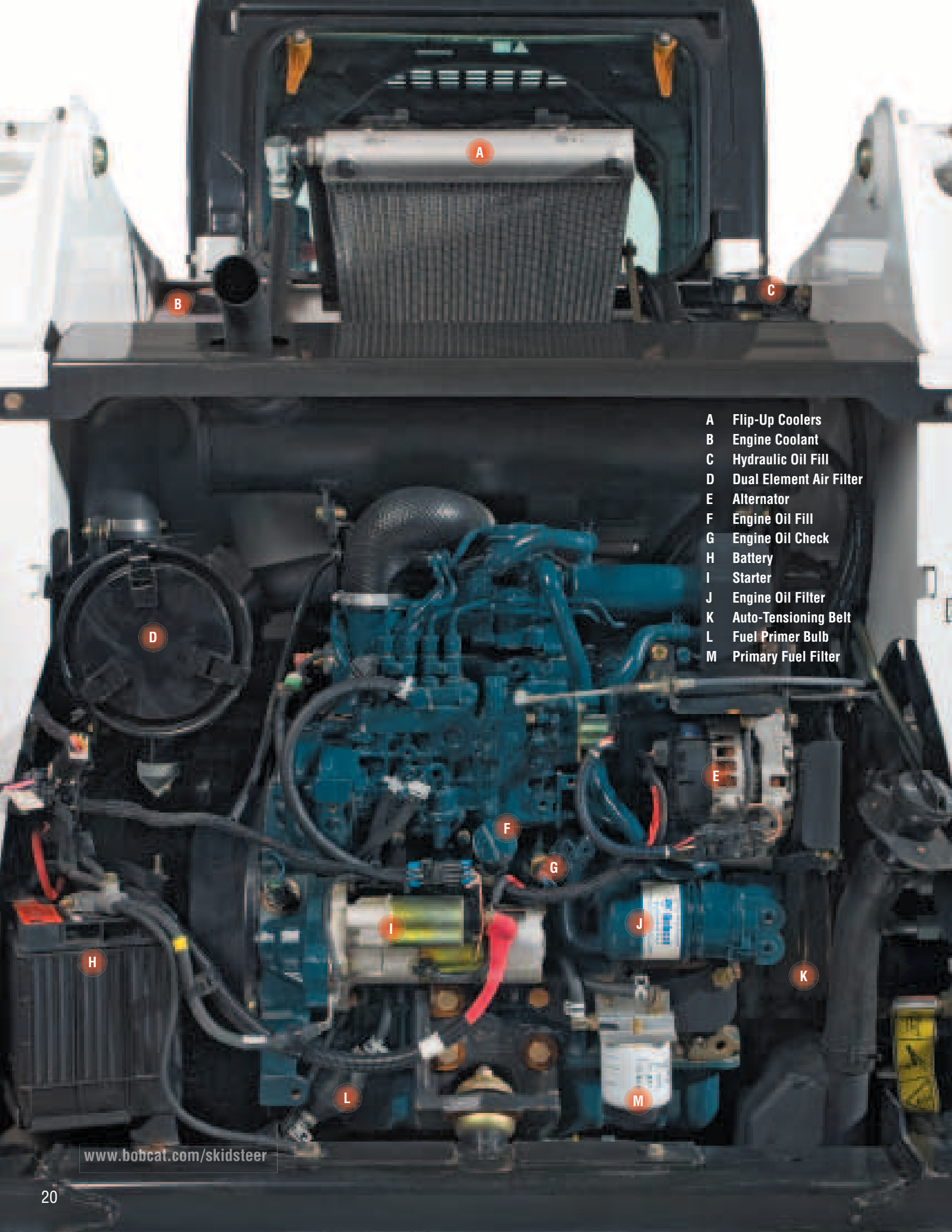

- A Flip-Up Coolers
- B Engine Coolant
- C Hydraulic Oil Fill
- D Dual Element Air Filter
- E Alternator
- F Engine Oil Fill
- G Engine Oil Check
- H Battery
- I Starter
- J Engine Oil Filter
- K Auto-Tensioning Belt
- L Fuel Primer Bulb
- M Primary Fuel Filter

# Panoramic Serviceability

Bobcat® loaders are designed to provide the fastest, easiest maintenance in the industry. Engine checkpoints are within easy reach – so daily maintenance actually gets done. Unparalleled access to routine and long-term maintenance points make preventative maintenance simple, reducing your operating costs and adding to your bottom line.



## Full-Access Serviceability

Our large, swing-open tailgate provides convenient access to routine maintenance points. There are no radiators to move, lift arms to raise or lift-arm support devices to install.

## Protective Tailgate

The one-piece, 1/4-inch, high-strength door has no cooling holes, slots or other openings that expose your loader components to job hazards.

## Tip-Up Cab

For non-routine service, simply remove two nuts and tip back the cab to access hydraulic and hydrostatic components in minutes.



The hydraulic oil cooler can be moved for easy cleaning and cleaning of the radiator.

It's excellent for loaders that work in debris-filled applications.

## The Transverse Engine and Belt Drive

Bobcat offers one-sided serviceability thanks to the exclusive Bobcat belt-drive system. This durable technology with a multi-groove, Kevlar™ belt allows your loader engine to run slower for reduced noise and longer durability. It's also more efficient with an optimized engine-to-pump package.



\* Refer to the loader Operation & Maintenance Manual for complete maintenance instructions and information.



## Quick Couplers

Trapped line pressure can make attachment changes anything but quick. So Bobcat loaders come with Quick Couplers to release trapped pressure. By pushing the coupler inward, hydraulic oil is released through a return line back into the machine. The result is clean, quick attachment changes every time.

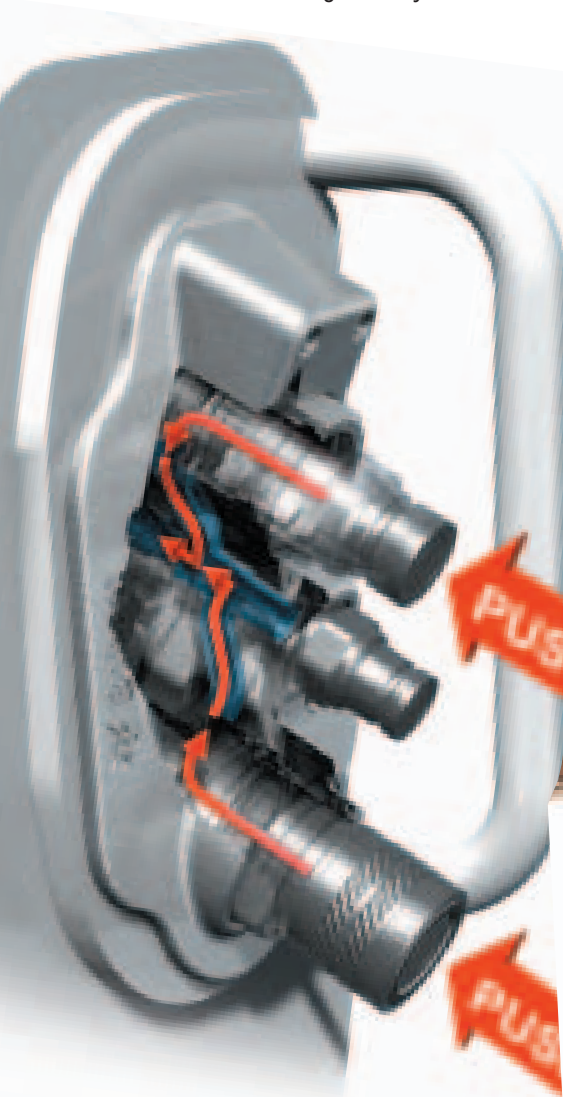

### Attachment Control Kit

Several attachments require control of more than one function. Our small, 7-pin attachment harness activates power and fingertip-control functions while eliminating the need for mechanical relays used on other loaders. It's fully integrated with your Bobcat loader for a clean look and protected routing.

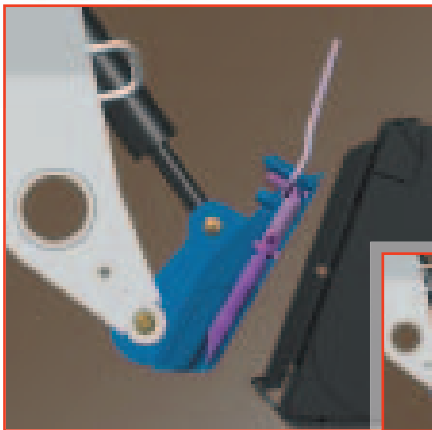

## Bob-Tach™

Change attachments in less than a minute with the Bob-Tach™ mounting system. Replace a bucket with a pallet fork, landscape rake, auger, grapple and more, while keeping a tight attachment fit every time.

# Do More



# Than Dig

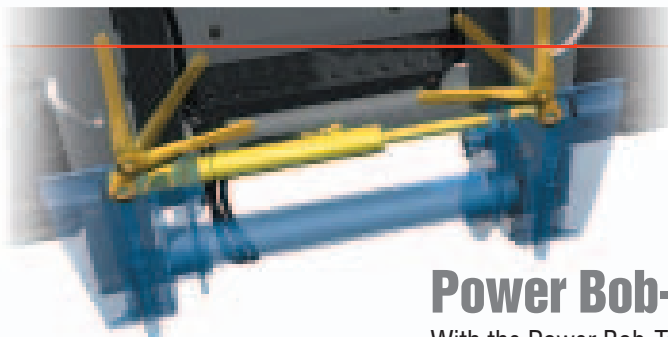

## Power Bob-Tach™

With the Power Bob-Tach™ system, you can change non-hydraulic attachments without leaving the comfort of your cab. Just line up the attachment and press the switch.



### **Deluxe Instrumentation Hour Clock**

Some attachments communicate with the Deluxe Instrumentation panel and have an hour clock associated with the attachment on the screen. For example, certain planers will communicate the number of hours on the attachment through the panel. This helps you improve maintenance by keeping track of service intervals for wear-control items, like planer teeth.



### **Laser Positioning**

For laser-controlled attachments, Deluxe Instrumentation enables you to make minor grade adjustments without leaving the cab.



### **Attachment Operation**

On the M-series Deluxe Instrumentation panel, you can monitor attachment operation on select attachments. For example, on the tree spade, you can monitor active blades and gates, change auto-dig and easy dig settings and keep track of the number of trees dug in a day.





Bobcat loaders have your business expansion built right in. An auger, breaker, or one of more than 70 attachments will go a long way to save you time and labor. Whether it's breaking concrete, taking down buildings or drilling tree holes, Bobcat attachments help you take on new jobs and get more use from your machine. They're vertically integrated with your Bobcat loader's electronics, hydraulics and geometry, and they're designed with visibility and ease of entry and exit in mind.

# Do More



# Than Dig

### **High-Flow Hydraulics**

Optional high-flow hydraulics provide a big power boost for better production with attachments. Certain attachments, such as the flail cutter, trencher, planer and stump grinder, get maximum performance from high-flow hydraulics.

### **Multi-Carrier Versatility**

Get more versatility and profitability for your dollar. Several Bobcat attachments can be used across carriers. For example, a Model 15 auger can be shared with an all-wheel steer loader, skid-steer loader, compact track loader, compact excavator, Toolcat™ utility work machine and VersaHandler® telescopic tool carrier.

### **Superior Attachment Availability**

Bobcat dealers specialize in compact equipment – so they are much more likely to stock or rent attachments that other equipment retailers don't even have. You'll be able to buy or rent the attachments you need.

### **Attachment Support**

The attachment is as important as your machine. If you buy an attachment off the internet or at a discount store, who is going to service it, provide parts and complete your warranty? Bobcat Company supports its attachments better than anyone. We are your one stop shop for your attachment parts, service, finance and warranty.



# All-Wheel Steer Innovation

Bobcat is famous for giving you more ways to get the job done. When you want maneuverability or turf-friendly performance on demand, only Bobcat delivers.



## Two steering modes by simply pressing a switch

The powerful A300 is the only compact loader in the industry that offers both all-wheel steer and skid-steer capabilities. This revolutionary loader operates with smooth, all-wheel steering that rolls through a turn without tearing up finished turf or leaving marks on driveways. When you need the unmatched maneuverability of a skid-steer loader, just press a switch and your loader can turn within its own length.

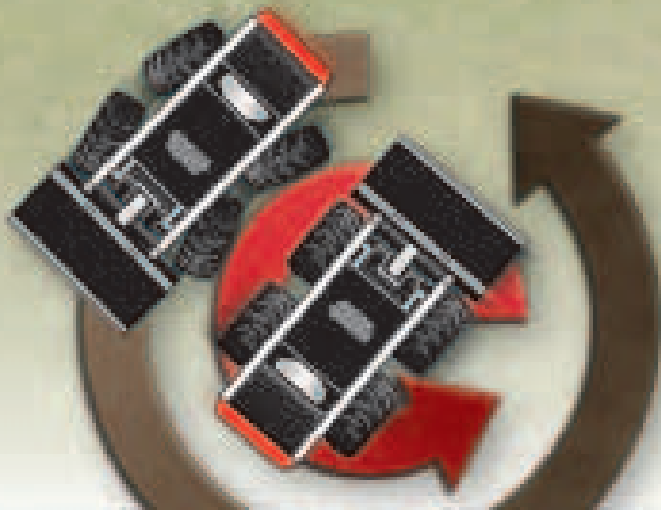

# Bobcat gives you more.

**More models. More features. More options. More versatility.**

With the all-wheel steer loader and 14 skid-steer loader models ranging from 35.5 to 79 inches wide and 23.5 to 92 hp, no one gives you more choices – or more machine for your money – than Bobcat. Get your choice of vertical lift path or radius lift path arm configurations. Take advantage of exclusive designs and groundbreaking technology. With Bobcat, you'll always get more, which means you'll have an easier time finding the machine that's matched to your job.



[www.bobcat.com/skidsteer](http://www.bobcat.com/skidsteer)



# Choice Controls

Bobcat® loaders offer the largest selection of control possibilities in the industry: all of the common control patterns found on compact loaders today. Plus, it's one of the only brands that allow you to choose your preference at the flip of a switch.



## Bobcat Standard Controls

With Bobcat Standard Controls, each steering lever controls each drive side independently, while dual foot pedals control the loader lift and tilt. It's still the most popular control style.



## Advanced Control System (ACS)

ACS offers your choice of two control styles in one machine. By pressing a switch, you can use traditional Bobcat Standard Controls or "H" pattern hand controls, where the left lever controls the left drive and lift, while the right lever controls the right drive and tilt.

## Selectable Joystick Controls (SJC)

Selectable Joystick Controls allow you to operate the machine with only your hands. You can easily switch between, "ISO" pattern, where left joystick operates the drive functions and the right joystick controls the workgroup, or "H" pattern with a dash-mounted rocker switch inside the cab. The low effort Selectable Joystick Controls also offer many job enhancing features listed to the right.



## Remote Control

With the Bobcat Loader Radio Remote Control System, you can control your loader without having to be in the cab. This system is available on machines with Selectable Joystick Controls or all-wheel steer loaders. This is a smart solution for hot, dusty environments or on jobs where you'd rather be outside of the machine. Completely portable, and designed for the worst working environments, the Radio Remote Control system is quickly installed or removed in minutes for easy use with multiple machines.



# Joystick Advantages

Bobcat Selectable Joystick Controls give you more features:

## Speed Management

A Bobcat exclusive. Simply "dial in" your required travel speed in small increments to match travel speed to your operation requirements and maximize attachment performance. Speed management gives you a full-range of joystick motion at a slower speed, giving you precise control of machine movements while maintaining maximum driveline torque and full hydraulic power.

## Steering Drift Compensation

Steering drift compensation keeps you on a straight path by helping you make minor adjustments to the steering. It's beneficial when you side-shift certain attachments, such as planers or trenchers, as this will tend to pull the machine to one side. You can also use it while driving on surfaces that cause the loader to gradually drift left or right, such as crowned roads. Make fine steering adjustments to either side and stay on target.

## Horsepower Management

Bobcat Horsepower Management automatically adjusts the loader drive system to maximize pushing and digging power while minimizing your chance of stalling. Unlike other anti-stall systems, Bobcat Horsepower Management lets the operator obtain maximum engine and drive torque to match the toughest digging conditions. If you prefer to work without it, simply disengage with the push of a button.

## Drive Response Mode

Drive response mode allows you to choose how the drive responds to joystick movement. Whether you like a smooth response, quick response or something in between, three different settings put you in control.

# Specifications

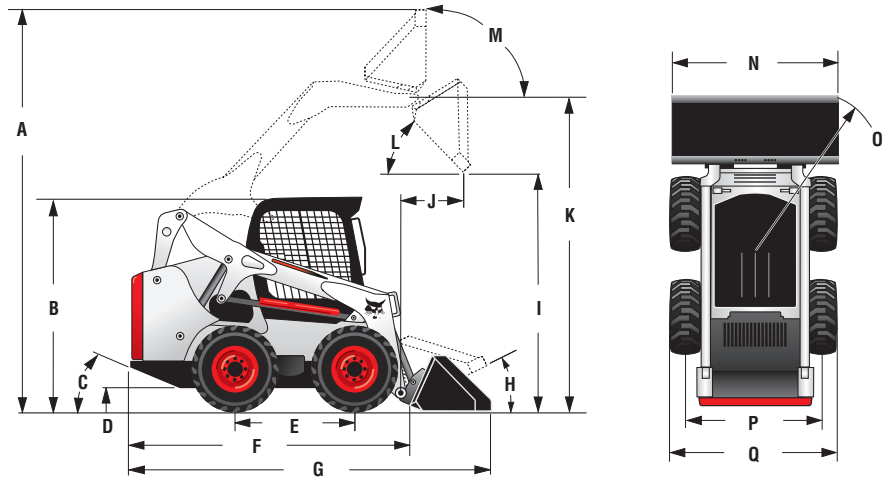

	S70	S100	S130	S150	S160	S175	S185
A	120.1 in. (3051 mm)	130.2 in. (3306 mm)	143.4 in. (3642 mm)	148 in. (3759 mm)	148 in. (3759 mm)	152.1 in. (3863 mm)	152.1 in. (3863 mm)
B	71.4 in. (1814 mm)	73.9 in. (1878 mm)	77.3 in. (1964 mm)	76.3 in. (1938 mm)	76.3 in. (1938 mm)	76.3 in. (1938 mm)	76.3 in. (1938 mm)
C	25°	25°	23°	23°	23°	23°	23°
D	5.5 in. (141 mm)	6.6 in. (167 mm)	7.4 in. (188 mm)	7.5 in. (191 mm)	7.5 in. (191 mm)	7.5 in. (191 mm)	7.5 in. (191 mm)
E	28.4 in. (722 mm)	32.2 in. (818 mm)	35.5 in. (900 mm)	40.6 in. (1030 mm)	40.6 in. (1030 mm)	40.6 in. (1030 mm)	40.6 in. (1030 mm)
F	75.6 in. (1925 mm)	89.1 in. (2263 mm)	95.8 in. (2432 mm)	101.8 in. (2586 mm)	101.8 in. (2586 mm)	101.9 in. (2588 mm)	101.9 in. (2588 mm)
G	97.3 in. (2472 mm)	110.2 in. (2800 mm)	124.1 in. (3152 mm)	130.3 in. (3310 mm)	130.3 in. (3310 mm)	130.3 in. (3310 mm)	130.3 in. (3310 mm)
H	25°	28°	27°	26°	26°	27°	27°
I	76.1 in. (1934 mm)	82 in. (2084 mm)	82.7 in. (2101 mm)	86.5 in. (2197 mm)	86.5 in. (2197 mm)	91 in. (2310 mm)	91 in. (2310 mm)
J	15.8 in. (400 mm)	15.4 in. (390 mm)	22.6 in. (575 mm)	18.1 in. (461 mm)	18.1 in. (461 mm)	29.6 in. (753 mm)	29.6 in. (753 mm)
K	94.5 in. (2399 mm)	103.6 in. (2633 mm)	109.5 in. (2781 mm)	114.5 in. (2908 mm)	114.5 in. (2908 mm)	118.2 in. (3002 mm)	118.2 in. (3002 mm)
L	34°	43°	40°	44°	44°	42°	42°
M	97°	95°	96°	92°	92°	95°	95°
N	36 in. (914 mm)	50 in. (1270 mm)	62 in. (1575 mm)	68 in. (1727 mm)	68 in. (1727 mm)	68 in. (1727 mm)	68 in. (1727 mm)
O	58.7 in. (1492 mm)	68.2 in. (1731 mm)	68.7 in. (1745 mm)	82.4 in. (2093 mm)	82.4 in. (2093 mm)	78.8 in. (2001 mm)	78.8 in. (2001 mm)
P	29.6 in. (752 mm)	38.1 in. (967 mm)	48.1 in. (1222 mm)	55.1 in. (1340 mm)	55.1 in. (1340 mm)	56.4 in. (1433 mm)	56.4 in. (1433 mm)
Q	35.5 in. (901 mm)	45.9 in. (1167 mm)	58.7 in. (1490 mm)	66 in. (1676 mm)	66 in. (1676 mm)	66 in. (1676 mm)	66 in. (1676 mm)

	S205	S630	S650	S250	S300	S330	S850	A300
A	152.1 in. (3863 mm)	155.5 in. (3950 mm)	158.5 in. (4026 mm)	163.3 in. (4148 mm)	163.3 in. (4148 mm)	164.3 in. (4173 mm)	178.6 in. (4536 mm)	163.3 in. (4148 mm)
B	76.3 in. (1938 mm)	81.3 in. (2065 mm)	81.3 in. (2065 mm)	80.9 in. (2055 mm)	80.9 in. (2055 mm)	82.2 in. (2088 mm)	83.4 in. (2118 mm)	80.9 in. (2055 mm)
C	23°	25°	25°	25°	25°	29°	27°	25°
D	7.5 in. (191 mm)	8.1 in. (207 mm)	8.1 in. (207 mm)	8.5 in. (216 mm)	8.5 in. (216 mm)	9.7 in. (247 mm)	9.4 in. (240 mm)	8.7 in. (221 mm)
E	40.6 in. (1030 mm)	45.3 in. (1150 mm)	45.3 in. (1150 mm)	48.3 in. (1227 mm)	48.3 in. (1227 mm)	48.3 in. (1227 mm)	52.9 in. (1342 mm)	48.3 in. (1227 mm)
F	101.9 in. (2588 mm)	108.4 in. (2754 mm)	108.4 in. (2754 mm)	114.5 in. (2908 mm)	114.5 in. (2908 mm)	114.5 in. (2908 mm)	119.3 in. (3030 mm)	114.5 in. (2908 mm)
G	130.3 in. (3310 mm)	136.8 in. (3474 mm)	136.8 in. (3474 mm)	142.9 in. (3630 mm)	142.9 in. (3630 mm)	142.9 in. (3630 mm)	147.7 in. (3751 mm)	142.9 in. (3630 mm)
H	27°	31°	31°	32°	32°	31°	31°	32°
I	91 in. (2310 mm)	93.2 in. (2367 mm)	96.3 in. (2447 mm)	101.8 in. (2586 mm)	101.8 in. (2586 mm)	102.4 in. (2601 mm)	116.2 in. (2951 mm)	101.8 in. (2586 mm)
J	29.6 in. (753 mm)	21.4 in. (544 mm)	31.5 in. (800 mm)	34 in. (864 mm)	34 in. (864 mm)	31.2 in. (792 mm)	29.7 in. (754 mm)	34 in. (864 mm)
K	118.2 in. (3002 mm)	121 in. (3073 mm)	124 in. (3149 mm)	128.8 in. (3272 mm)	128.8 in. (3272 mm)	130 in. (3305 mm)	144 in. (3657 mm)	128.8 in. (3272 mm)
L	42°	42°	42°	40°	40°	40°	42°	40°
M	95°	97°	97°	98°	98°	98°	98°	98°
N	68 in. (1727 mm)	74 in. (1880 mm)	74 in. (1880 mm)	74 in. (1880 mm)	74 in. (1880 mm)	74 in. (1880 mm)	80 in. (2032 mm)	74 in. (1880 mm)
O	78.8 in. (2001 mm)	83.4 in. (2119 mm)	82.9 in. (2106 mm)	84.2 in. (2139 mm)	84.2 in. (2139 mm)	86.2 in. (2189 mm)	89 in. (2262 mm)	84.2 in. (2139 mm)
P	54.5 in. (1382 mm)	59.3 in. (1507 mm)	59.3 in. (1507 mm)	60.3 in. (1532 mm)	60.3 in. (1532 mm)	59.5 in. (1511 mm)	65.1 in. (1652 mm)	62.2 in. (1580 mm)
Q	66 in. (1676 mm)	72.1 in. (1832 mm)	72.1 in. (1832 mm)	72 in. (1829 mm)	72 in. (1829 mm)	73.3 in. (1861 mm)	79 in. (2005 mm)	74 in. (1880 mm)

# Specifications and Features AWS and Skid-Steer Loaders



Loader	S70	S100	S130	S150	S160	S175
Loader Series	K-Series	K-Series	K-Series	K-Series	K-Series	K-Series
Rated Operating Capacity (ROC)	700 lb. (318 kg)	1000 lb. (453 kg)	1300 lb. (590 kg)	1500 lb. (680 kg)	1600 lb. (726 kg)	1750 lb. (794 kg)
ROC with Counterweight (optional)	-	-	-	-	-	Counterweight kits are
Tipping Load	1542 lb. (686 kg)	2002 lb. (908 kg)	2634 lb. (1195 kg)	3101 lb. (1407 kg)	3201 lb. (1452 kg)	4126 lb. (1872 kg)
Height to Hinge Pin	94.5 in. (2399 mm)	103.6 in. (2633 mm)	109.5 in. (2781 mm)	114.5 in. (2908 mm)	114.5 in. (2908 mm)	118.2 in. (3002 mm)
Lift Arm Path	Radius	Radius	Radius	Radius	Radius	Vertical
<b>Size and Speed</b>						
Operating Weight	2795 lb. (1268 kg)	4091 lb. (1856 kg)	5235 lb. (2375 kg)	5935 lb. (2692 kg)	5965 lb. (2706 kg)	6290 lb. (2853 kg)
Bucket Width	36 in. (914 mm)	50 in. (1270 mm)	62 in. (1575 mm)	68 in. (1727 mm)	68 in. (1727 mm)	68 in. (1727 mm)
Cab Height	71.4 in. (1814 mm)	73.9 in. (1878 mm)	77.3 in. (1964 mm)	76.3 in. (1938 mm)	76.3 in. (1938 mm)	76.3 in. (1938 mm)
Travel Speed-Low Range	6.1 mph (9.8 km/hr.)	6.4 mph (10.3 km/hr.)	7.3 mph (11.8 km/hr.)	7.3 mph (11.8 km/hr.)	7.3 mph (11.8 km/hr.)	7.3 mph (11.8 km/hr.)
Travel Speed-High Range	-	8.7 mph (14 km/hr.)	-	11.1 mph (17.9 km/hr.)	11.1 mph (17.9 km/hr.)	11.1 mph (17.9 km/hr.)
<b>Engine</b>						
Horsepower	Interim Tier IV Compliant 23.5 hp	Interim Tier IV Compliant 35.5 hp	Interim Tier IV Compliant 49 hp	Interim Tier IV Compliant 49 hp	Interim Tier IV Compliant 61 hp	Interim Tier IV Compliant 49 hp
Type	Diesel	Diesel	Diesel	Diesel	Turbo Diesel	Diesel
Fuel Tank Capacity	6.5 gal. (24.6 L)	11.9 gal. (45 L)	13.3 gal. (50.4 L)	24 gal. (91 L)	24 gal. (91 L)	24 gal. (91 L)
Horsepower Management	-	-	-	-	-	-
<b>Uptime Protection</b>						
Axle Grease	never	never	never	never	never	never
Axle Seal Protection	Std	Std	Std	Std	Std	Std
Bobcat SmartFAN™	-	-	Std	Std	Std	Std
Dual Path Cooling System	-	Std	Std	Std	Std	Std
Machine Shutdown Protection	Opt	Std	Std	Std	Std	Std
Required Chain Adjustment	never	never	never	never	never	never
<b>Tires</b>						
Bobcat Standard Duty	Std	-	Std	Std	Std	Std
Bobcat Heavy Duty	Opt	Std	Opt	Opt	Opt	Opt
Bobcat Severe Duty	-	-	Opt	Opt	Opt	Opt
Bobcat Super Float	-	-	-	-	-	-
<b>Control Options</b>						
Bobcat Standard (foot pedals/steering levers)	Std	Std	Std	Std	Std	Std
Advance Control System (ACS)	-	-	Opt	Opt	Opt	Opt
Selectable Joystick Control (SJC)	-	Opt	Opt	Opt	Opt	Opt
Dual Steering Mode (All-Wheel Steer or Skid-Steer)	-	-	-	-	-	-
Radio Remote Control (SJC Required)	-	-	Opt	Opt	Opt	Opt
<b>Machine Features</b>						
Air Ride Seat	-	Opt	Opt	Opt	Opt	Opt
Back-up Alarm & Horn	Std	Std	Std	Std	Std	Std
Bobcat Interlock Control System (BICS™)	Std	Std	Std	Std	Std	Std
Cab with Heat	Opt	Opt	Opt	Opt	Opt	Opt
Cab with Heat & Air Conditioning	-	-	-	-	Opt	-
Deluxe Instrumentation (includes Keyless Start)	Opt	Opt	Opt	Opt	Opt	Opt
Hydraulic Bucket Positioning	Opt	Opt	Opt	Opt	Opt	Opt
Mechanical Suspension Seat	Opt	Opt	Opt	Opt	Opt	Opt
Front and Rear Work Lights	Std	Std	Std	Std	Std	Std
Radio	Opt	Opt	Opt	Opt	Opt	Opt
Ride Control	-	-	Opt	Opt	Opt	Opt
ROPS/FOPS Approved Cab Structure	Std	Std	Std	Std	Std	Std
Sound Reduction Package	Opt	Opt	Opt	Opt	Opt	Opt
2-Speed	-	Opt (w/SJC)	-	Opt	Opt	Opt
<b>Features for Attachments</b>						
Attachment Control Kit	Opt	Opt	Opt	Opt	Opt	Opt
Bob-Tach™ Mounting System	Std	Std	Std	Std	Std	Std
Power Bob-Tach™	-	-	Opt	Opt	Opt	Opt
Fingertip Auxiliary Hydraulics Control	-	-	Std	Std	Std	Std
Hydraulic System Pressure	3000 psi	3000 psi	2700 psi	3300 psi	3300 psi	3300 psi
Hydraulic Standard Flow	9.8 gpm (37.1 L/min.)	13.1 gpm (49.6 L/min.)	16.9 gpm (64 L/min.)	16.9 gpm (64 L/min.)	16.9 gpm (64 L/min.)	16.9 gpm (64 L/min.)
Hydraulic High Flow (optional)	-	-	-	-	26.4 gpm (100 L/min.)	-
Pressure Release Hydraulic Quick Couplers	-	Opt (w/SJC)	Std	Std	Std	Std
Speed Management	-	-	-	-	-	-



S185	S205	S630	S650	S250	S300	S330	S850	A300
K-Series	K-Series	M-Series	M-Series	K-Series	K-Series	K-Series	M-Series	K-Series
1850 lb. (839 kg)	2050 lb. (930 kg)	2180 lb. (989 kg)	2690 lb. (1220 kg)	2500 lb. (1135 kg)	3000 lb. (1362 kg)	3300 lb. (1497 kg)	3875 lb. (1758 kg)	3000 lb. (1362 kg)
available to increase ROC. See dealer on available kits and ROC increases for your loader.								
4076 lb. (1849 kg)	4451 lb. (2019 kg)	4360 lb. (1978 kg)	5380 lb. (2440 kg)	5661 lb. (2568 kg)	6111 lb. (2772 kg)	6720 lb. (3048 kg)	7750 lb. (3515 kg)	6111 lb. (2772 kg)
118.2 in. (3002 mm)	118.2 in. (3002 mm)	121 in. (3073 mm)	124 in. (3149 mm)	128.8 in. (3272 mm)	128.8 in. (3272 mm)	130.1 in. (3305 mm)	144 in. (3657 mm)	128.8 in. (3272 mm)
Vertical	Vertical	Radius	Vertical	Vertical	Vertical	Vertical	Vertical	Vertical
6220 lb. (2821 kg)	6655 lb. (3019 kg)	7707 lb. (3496 kg)	8327 lb. (3777 kg)	7825 lb. (3549 kg)	8268 lb. (3750 kg)	9185 lb. (4166 kg)	10008 lb. (4540 kg)	8673 lb. (3934 kg)
68 in. (1727 mm)	68 in. (1727 mm)	74 in. (1880 mm)	74 in. (1880 mm)	74 in. (1880 mm)	74 in. (1880 mm)	74 in. (1880 mm)	80 in. (2032 mm)	74 in. (1880 mm)
76.3 in. (1938 mm)	76.3 in. (1938 mm)	81.3 in. (2065 mm)	81.3 in. (2065 mm)	80.9 in. (2055 mm)	80.9 in. (2055 mm)	82.2 in. (2088 mm)	83.4 in. (2118 mm)	80.9 in. (2055 mm)
7.3 mph (11.8 km/hr.)	7.3 mph (11.8 km/hr.)	7.1 mph (11.4 km/hr.)	7.1 mph (11.4 km/hr.)	6.9 mph (11.1 km/hr.)	6.9 mph (11.1 km/hr.)	6.9 mph (11.1 km/hr.)	7.1 mph (11.4 km/hr.)	6.9 mph (11.1 km/hr.)
11.1 mph (17.9 km/hr.)	11.1 mph (17.9 km/hr.)	12.3 mph (19.8 km/hr.)	12.3 mph (19.8 km/hr.)	12.0 mph (19.1 km/hr.)	12.0 mph (19.1 km/hr.)	12.0 mph (19.1 km/hr.)	12.3 mph (19.8 km/hr.)	12.0 mph (19.1 km/hr.)
Interim Tier IV Compliant	Interim Tier IV Compliant	Interim Tier IV Compliant	Interim Tier IV Compliant	Tier III Compliant	Tier III Compliant	Tier III Compliant	Tier III Compliant	Tier III Compliant
61 hp	66 hp	74.3 hp	74.3 hp	75 hp	81 hp	85 hp	92 hp	81 hp
Turbo Diesel	Turbo Diesel	Turbo Diesel	Turbo Diesel	Turbo Diesel	Turbo Diesel	Turbo Diesel	Turbo Diesel	Turbo Diesel
24 gal. (91 L)	24 gal. (91 L)	27.3 gal. (103.3 L)	27.3 gal. (103.3 L)	23 gal. (87 L)	23 gal. (87 L)	23 gal. (87 L)	32.8 gal. (124.2 L)	23 gal. (87 L)
Included with SJC Option								Std
never	never	never	never	never	never	never	never	never
Std	Std	Std	Std	Std	Std	Std	Std	Std
Std	Std	Std	Std	Std	Std	Std	Std	Std
Std	Std	Std	Std	Std	Std	Std	Std	Std
Std	Std	Std	Std	Std	Std	Std	Std	Std
never	never	never	never	never	never	never	never	never
Std	-	-	-	-	-	-	-	-
Opt	Opt	Std	Std	Std	Std	Std	Std	Std
Opt	Opt	Opt	Opt	Opt	Opt	Opt	Opt	Opt
-	Std	Opt	Opt	Opt	Opt	-	-	Opt
Std	Std	Std	Std	Std	Std	Std	Std	-
Opt	Opt	Opt	Opt	Opt	Opt	Opt	-	-
Opt	Opt	Opt	Opt	Opt	Opt	Opt	Opt	-
-	-	-	-	-	-	-	-	Std
Opt	Opt	Opt	Opt	Opt	Opt	Opt	Opt	Opt
Opt	Opt	Opt	Opt	Opt	Opt	Opt	Opt	Opt
Std	Std	Std	Std	Std	Std	Std	Std	Std
Opt	Opt	Opt	Opt	Opt	Opt	Opt	Opt	Opt
Opt	Opt	Opt	Opt	Opt	Opt	Opt	Opt	Opt
Opt	Opt	Opt	Opt	Opt	Opt	Opt	Opt	Opt
Opt	Opt	Opt	Opt	Opt	Opt	Opt	Opt	Opt
Std	Std	Std	Std	Std	Std	Std	Std	Std
Opt	Opt	Opt	Opt	Opt	Opt	Opt	Opt	Opt
Opt	Opt	Opt	Opt	Opt	Opt	Std	Std	Std
Opt	Opt	Opt	Opt	Opt	Opt	Opt	Opt	Opt
Opt	Opt	Opt	Opt	Opt	Opt	Opt	Opt	Opt
Std	Std	Std	Std	Std	Std	Std	Std	Std
Opt	Opt	Opt	Opt	Opt	Opt	Opt	Opt	Opt
Opt	Opt	Opt	Opt	Opt	Opt	Std	Std	Std
Opt	Opt	Opt	Opt	Opt	Opt	Opt	Opt	Opt
Std	Std	Std	Std	Std	Std	Std	Std	Std
Opt	Opt	Opt	Opt	Opt	Opt	Opt	Opt	Opt
Opt	Opt	Opt	Opt	Opt	Opt	Opt	Opt	Opt
3300 psi	3300 psi	3500 psi	3500 psi	3300 psi	3300 psi	3300 psi	3500 psi	3300 psi
16.9 gpm (64 L/min.)	16.9 gpm (64 L/min.)	23 gpm (87.1 L/min.)	23 gpm (87.1 L/min.)	20.7 gpm (78 L/min.)	20.7 gpm (78 L/min.)	20.7 gpm (78 L/min.)	23 gpm (87.1 L/min.)	20.7 gpm (78 L/min.)
26.4 gpm (100 L/min.)	26.4 gpm (100 L/min.)	30.5 gpm (115.5 L/min.)	30.5 gpm (115.5 L/min.)	37 gpm (140 L/min.)	37 gpm (140 L/min.)	37 gpm (140 L/min.)	37 gpm (140 L/min.)	37 gpm (140 L/min.)
Std	Std	Std	Std	Std	Std	Std	Std	Std
Included with SJC Option (see attachment section for details)								Std



# The leader in versatility and maneuverability.



Attachments



Skid-Steer Loaders



Compact Track Loaders



All-Wheel Steer Loader



Compact Excavators

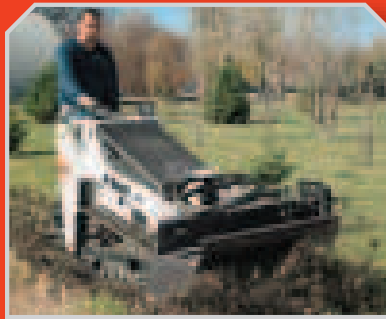

Mini Track Loaders



VersaHandler® Telescopic Tool Carriers



Toolcat™ Utility Work Machines



Utility Vehicles



Compact Tractors



## Get Bobcat Gear!

Find cool Bobcat® gear and accessories by visiting your local Bobcat dealer or [www.BobcatStore.com](http://www.BobcatStore.com)

# Bobcat History

## Pioneering Maneuverability:

Bobcat introduced its first compact loader in 1958 and two years later, the world's first skid-steer loader. This created an entire industry of machines that put the power of large equipment in a compact size with unmatched maneuverability.



## Offering More Versatility:

In 1970 Bobcat invented the first quick-change attachment system for skid-steer loaders known as the Bob-Tach™ mounting system. Today we offer more attachments than anyone in the world, empowering customers to transform all our machines into multi-task attachment carriers and reach higher levels of production.

## One Tough Animal:

All over the world, Bobcat equipment is known for being durable and dependable. By lasting longer and minimizing down time, we help our customers become as successful as possible.

## Help When You Need It:

With 50 years of experience and more than 550 locations, we offer the best dealer network in the country for compact equipment. Our dealers offer a quality sales force, dependable parts departments and qualified service technicians, all leading to a quality customer experience.



## Leader by Design:

Listening to the customer and a pioneering spirit are why Bobcat continues to lead the evolution of compact equipment...

- 1960** – Invented the **FIRST** true skid-steer loader.
- Today** – One out of every two skid-steers is a Bobcat loader.
- 1970** – Invented the **FIRST** attachment mounting system for skid-steer loaders.
- Today** – Bobcat Company manufactures more attachments than anyone in the world.
- 1977** – Built the **FIRST** skid-steer with no chain adjustments required.
- Today** – Still a Bobcat exclusive.
- 1981** – The **FIRST** secondary restraint seat bar is introduced.
- Today** – Bobcat is the only company that offers operator training kits for compact equipment.
- 1983** – The **FIRST** skid-steer with a transversely mounted engine.
- Today** – Still a Bobcat exclusive.
- 1986** – Introduced the **FIRST** compact excavator manufactured in the U.S.
- Today** – Still the only compact excavator manufactured in the U.S.
- 1999** – Introduced the **FIRST** compact track loader with a solid-mounted undercarriage manufactured in the U.S.
- Today** – One out of every two compact track machines is a Bobcat.
- 2001** – Invented the **FIRST** loader with all-wheel steer and skid-steer capabilities.
- Today** – Still a Bobcat exclusive.
- 2003** – Revolutionized the way the world works with the invention of the Toolcat™ line, the world's **FIRST** utility work machines – a cross between a pickup, attachment carrier and utility vehicle.
- Today** – The Toolcat utility work machine– still the only one of its kind.
- 2006** – Introduced the **FIRST** utility vehicle with RapidLink™ Attachment System.
- 2007** – Bobcat launches its new line of compact tractors.
- 2008** – Roller Suspension, the **FIRST** all-steel suspension system, is introduced.
- 2009** – Released M-Series compact excavators and loaders.

## A Constant Innovator:

In the late 1950s, a turkey farmer needed help – so in 1958 we introduced what was to become the world's first skid-steer loader. We created an industry by listening to the needs of the customer. This focus is the same today. In 2000, a superintendent needed help – so we built the world's first Toolcat utility work machine. We continue to be a global leader in innovation by listening to our customers.

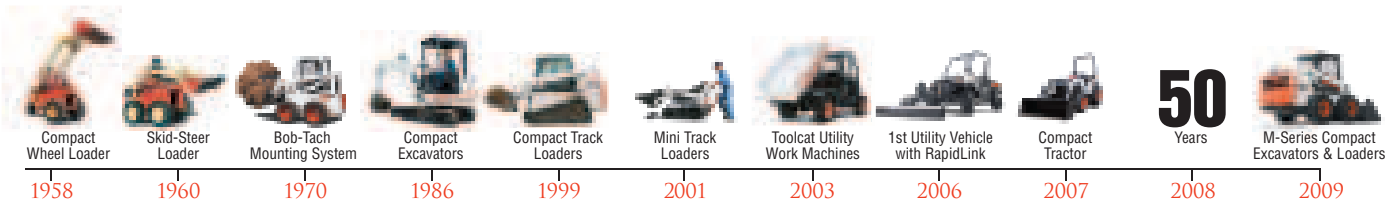

# BOBCAT TIMELINE

# TESTOSTERONE COMES STANDARD.

Unrivaled versatility. Unequaled agility. Unsurpassed performance and innovation. That's why Bobcat® is the world leader in compact equipment. No one offers more ways to get your work done... or flaunt your virility.



**Bobcat**®

[www.bobcat.com/skidsteer](http://www.bobcat.com/skidsteer)

*One Tough Animal.*



Printed on 10%  
recycled paper

B-1858 (6/2010)

**Bobcat Company**

P.O. Box 6000 • West Fargo, ND 58078

[www.bobcat.com](http://www.bobcat.com)

Printed in U.S.A.

Kn-40M-610-#18045-F